



## JD Series LED Street Light Product



SABER



Zhongshanshi Jian Neng Lighting Technology Co., Ltd  
26#No.6 Lefeng Road ,HengLanTown ZhongShan City , GuangDong Province,China  
Email: [info@solarluminaire.com](mailto:info@solarluminaire.com)  
[www.solarluminaire.com](http://www.solarluminaire.com)

Overview



Thermal Management

Structure is optimized by advanced FEA technology. Well managed temperature rise between internal and external parts. Even thermal distributions. Higher lumen maintenance rate.

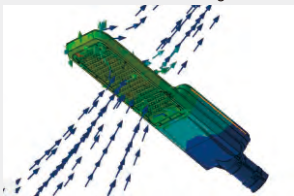

Thermal Air Convection



Thermal Effects to Air

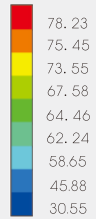

Unit : °C

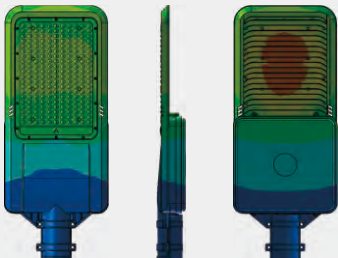

Thermal Conductivity

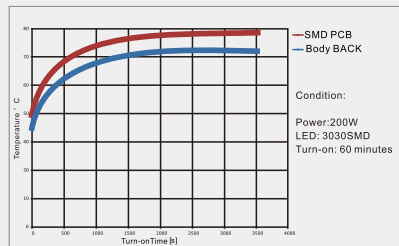

Temperature Rise

## Exploded

Optional with sensor

Die-casting aluminum cover

UV-proof & waterproof silicone gel

ADC12 die-casting aluminum body  
thermal efficiency up to 96W/M.K.

Brand waterproof LED driver

Highly thermal conductive aluminum pcb  
3030SMD light source, lighting  
efficiency up to 120lm/W

UV-proof & waterproof silicone gel

UV-proof optical lens, Precision  
road lighting distributions

AC and solar solutions are optional.

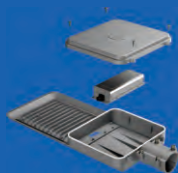

AC solutions



Solar solutions



AC solutions



Solar solutions

## Diagrams

Unit:mm

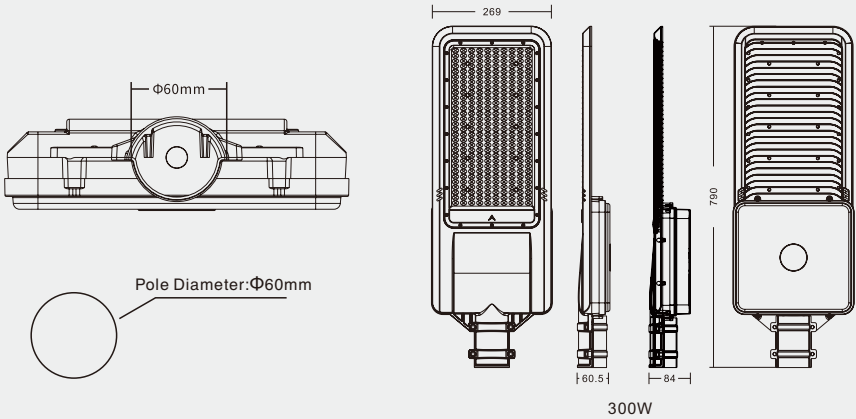
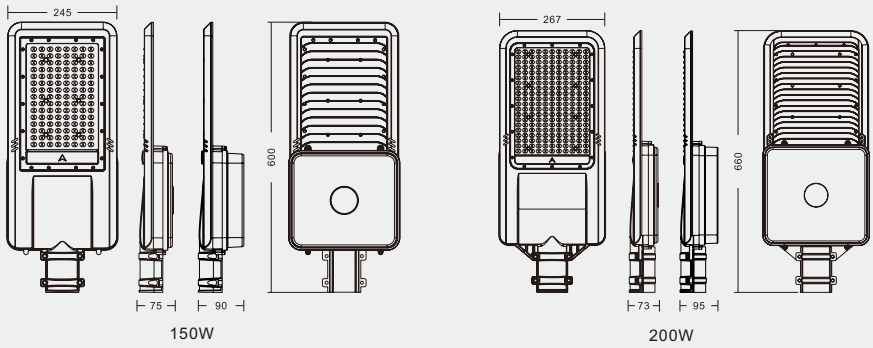
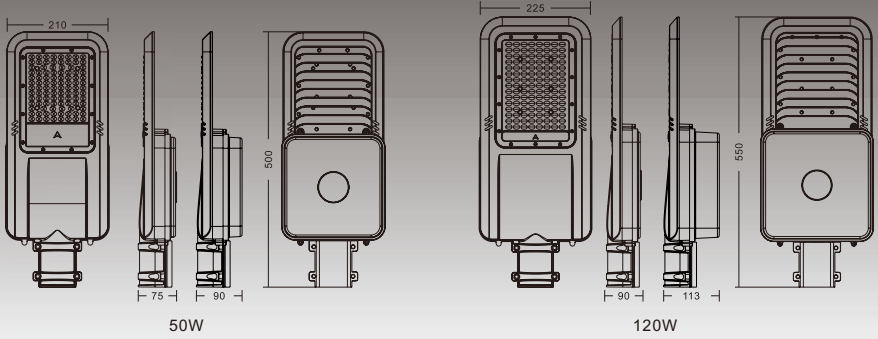

## Product Parameters



ITEM	JD01-50W
Nominal Power	50W
Input Voltage	AC85-265V, 50/60Hz
LED Quantity	SMD 3030 50pcs
Lamp Body Size (mm)	500*210*65mm
CCT	6500K/3200K/4000K optional
CRI	>70
Protection Grade	IP67, IK08
LED Brand	San An
Luminous Flux	110-130LM/W
Operating Temperature	-20°C to 60°C
Warranty	3 Years
Material	Aluminum
LED Driver	Meanwell/MoSo/Philips
Power Factor	>0.95
PCB	10B5C
G.W. (lamp body)	1.52Kg
Box Size (lamp body)	530*215*90mm/pcs
CTN Packing (lamp body)	500*225*545mm/5pcs

## Distribution

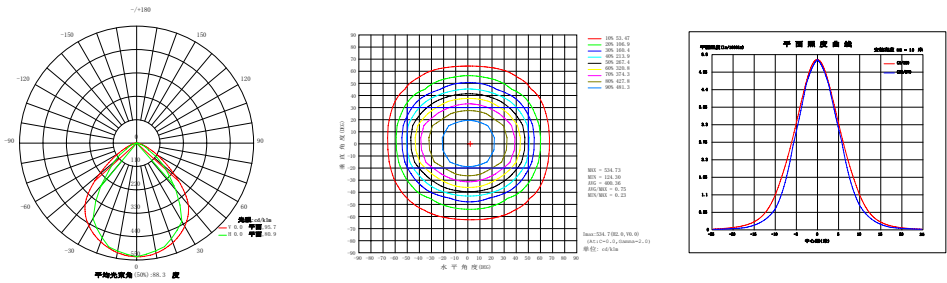

Carton	Measurement	N.W	G.W	QTY
Double Wall	650*310*230mm	6Kg	8.2Kg	5Pcs/CTN

Container	CTNS	Q'TY	Volume (M³)
20" standard	424Ctns	2120pcs	25.4 M³
40" standard	1076Ctns	5382pcs	64.6 M³

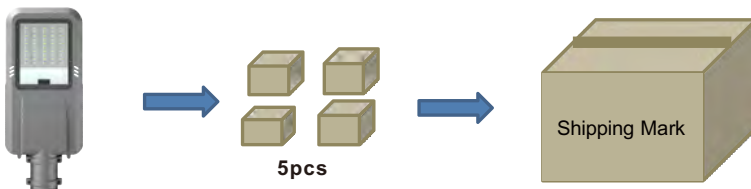

## Product Parameters



ITEM	JD02-100W
Nominal Power	100W
Input Voltage	AC85-265V, 50/60Hz
LED Quantity	SMD 3030 120pcs
Lamp Body Size (mm)	550*225*65mm
CCT	6500K/3200K/4000K optional
CRI	>70
Protection Grade	IP67, IK08
LED Brand	San An
Luminous Flux	110-130LM/W
Operating Temperature	-20°C to 60°C
Warranty	3 Years
Material	Aluminum
LED Driver	Meanwell/MOSO/Philips
Power Factor	>0.95
PCB	24B5C
G.W. (lamp body)	1.63Kg
Box Size (lamp body)	560*230*100mm/pcs
CTN Packing (lamp body)	515*245*575mm/4pcs

## Distribution

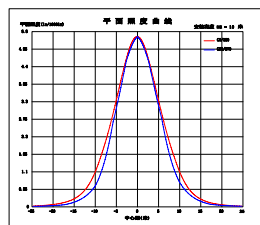
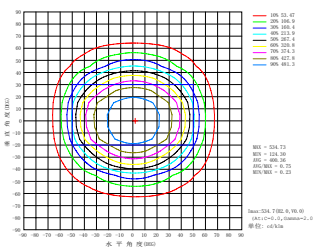
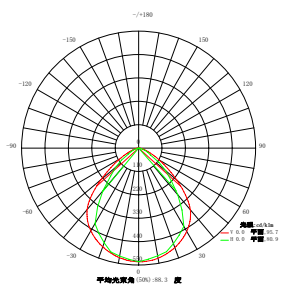

Carton	Measurement	N.W	G.W	QTY
Double Wall	515*245*575mm	6.3Kg	6.5Kg	4Pcs/CTN

Container	CTNS	Q'TY	Volume (M³)
20" standard	358Ctns	1433pcs	25.1 M³
40" standard	771Ctns	3087pcs	54.1 M³

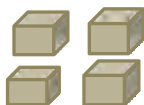

## Product Parameters



ITEM	JD03-150W
Nominal Power	150W
Input Voltage	AC85-265V, 50/60Hz
LED Quantity	SMD 3030 150pcs
Lamp Body Size (mm)	600*245*70mm
CCT	6500K/3200K/4000K optional
CRI	>70
Protection Grade	IP67, IK08
LED Brand	San An
Luminous Flux	110-130LM/W
Operating Temperature	-20°C to 60°C
Warranty	3 Years
Material	Aluminum
LED Driver	Meanwell/MOSO/Philips
Power Factor	>0.95
PCB	30B5C
G.W. (lamp body)	2.25Kg
Box Size (lamp body)	610*260*120mm/pcs
CTN Packing (lamp body)	610*260*120mm/pcs

## Distribution

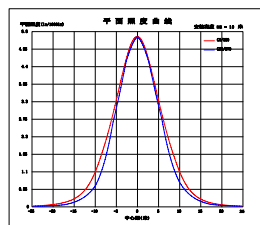
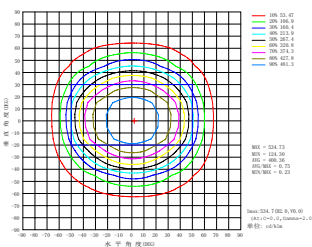
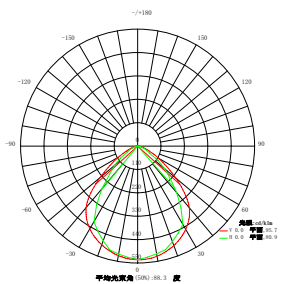

Carton	Measurement	N.W	G.W	QTY
Double Wall	610*260*120mm	1.9Kg	2.2Kg	1Pcs/CTN

Container	CTNS	Q'TY	Volume (M <sup>3</sup> )
20" standard	1366Ctns	1366pcs	27.3 M <sup>3</sup>
40" standard	2942Ctns	2942pcs	58.8 M <sup>3</sup>

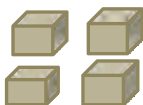

1pcs



## Product Parameters



ITEM	JD04-200W
Nominal Power	200W
Input Voltage	AC85-265V, 50/60Hz
LED Quantity	SMD 3030 200pcs
Lamp Body Size (mm)	660*265*70mm
CCT	6500K/3200K/4000K optional
CRI	>70
Protection Grade	IP67, IK08
LED Brand	San An
Luminous Flux	110-130LM/W
Operating Temperature	-20°C to 60°C
Warranty	3 Years
Material	Aluminum
LED Driver	Meanwell/MOSO/Philips
Power Factor	>0.95
PCB	40B5C
G.W. (lamp body)	3.95Kg
Box Size (lamp body)	670*280*100mm/pcs
CTN Packing (lamp body)	670*280*100mm/pcs

## Distribution

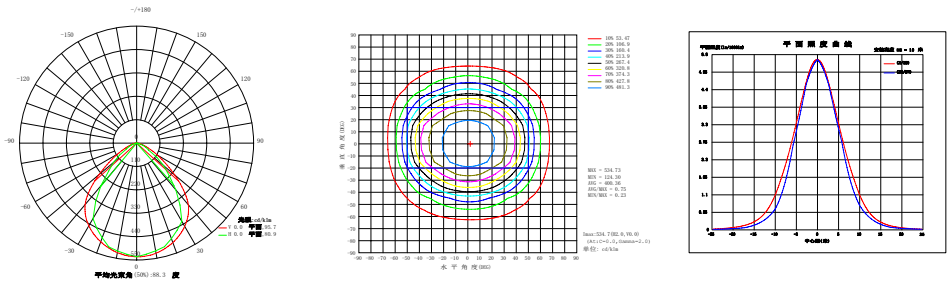

Carton	Measurement	N.W	G.W	QTY
Double Wall	670*280*100mm	3.3Kg	3.9Kg	1Pcs/CTN

Container	CTNS	Q'TY	Volume (M³)
20" standard	1386Ctns	1386pcs	27.7 M³
40" standard	2985Ctns	2985pcs	59.7 M³

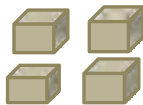

1pcs





## Product Parameters



ITEM	JD05-300W
Nominal Power	300W
Input Voltage	AC85-265V, 50/60Hz
LED Quantity	SMD 3030 300pcs
Lamp Body Size (mm)	790*265*100mm
CCT	6500K/3200K/4000K optional
CRI	>70
Protection Grade	IP67, IK08
LED Brand	San An
Luminous Flux	110-130LM/W
Operating Temperature	-20°C to 60°C
Warranty	3 Years
Material	Aluminum
LED Driver	Meanwell/MOSO/Philips
Power Factor	>0.95
PCB	60B5C
G.W. (lamp body)	4.38Kg
Box Size (lamp body)	800*280*100mm/pcs
CTN Packing (lamp body)	800*280*100mm/pcs

## Distribution

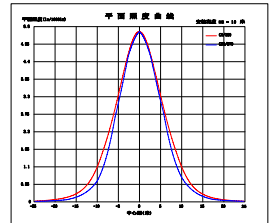
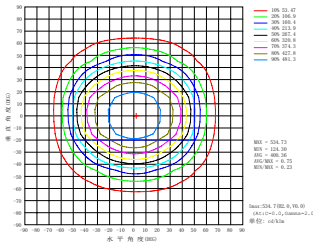
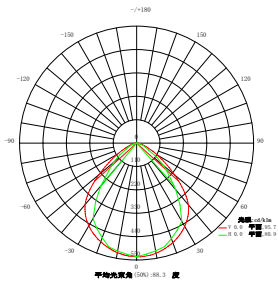

Carton	Measurement	N.W	G.W	QTY
Double Wall	800*280*100mm	3.9Kg	4.3Kg	1Pcs/CTN

Container	CTNS	Q'TY	Volume (M³)
20" standard	1161Ctns	1161pcs	23.2 M³
40" standard	2500Ctns	2500pcs	50.1 M³

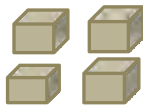

1pcs



## Applications

Widely use for road, freeway, park, plaza and villa

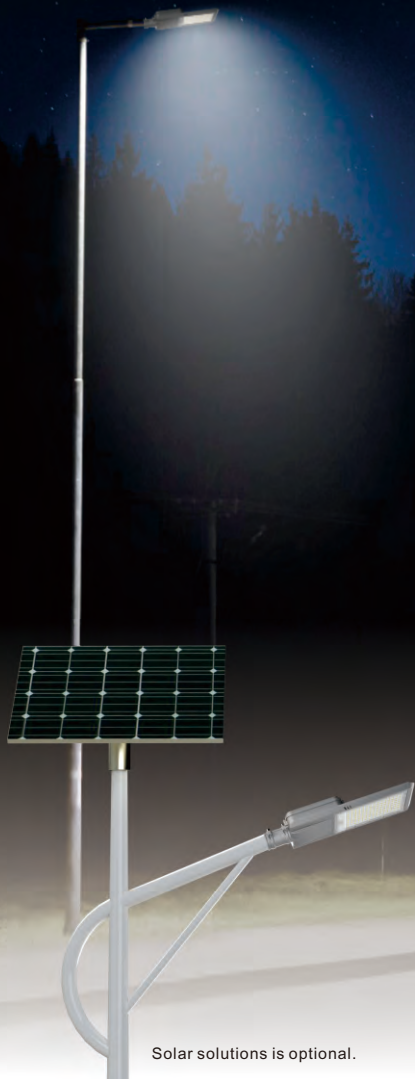

Solar solutions is optional.

lamp color is optional.



Gray



White

## Optics

### TECHNICAL SUPPORT

- Simulations to show optic performance in real applications
- Thermal analysis for luminaire designs
- Guides and tips for installations
- Free for all our customers

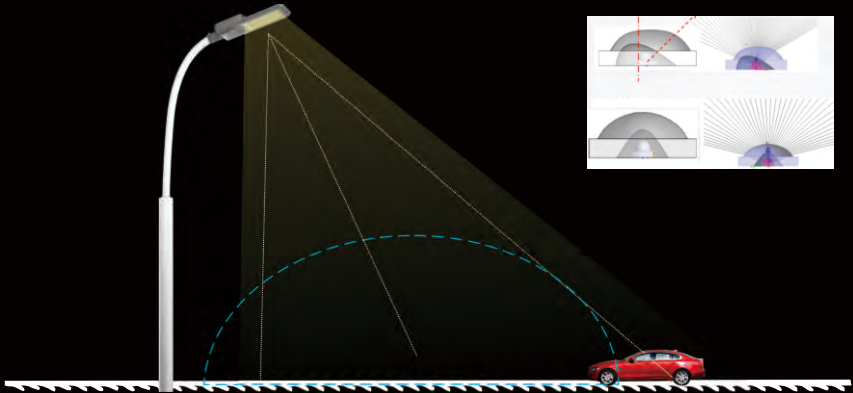

Energy Saving Design



Highly Uniformity Design



Cut-off Angle Design

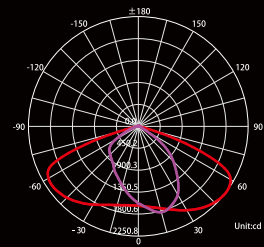

C plane lighting distributions

## Packing Pictures



## Series Products



## Series Packing Parameters

Model No.	Color Box (mm)	Weight (KG)	CTN SIZE (mm)	CTN (pcs)	Weight (KG)
JD01-50W	530*215*90mm	1.5KG	500*225*545mm	5pcs	7.25KG
JD02-100W	560*230*100mm	1.6KG	515*245*575mm	4pcs	6.32KG
JD03-150W	610*260*120mm	2.2KG	610*260*120mm	1pcs	2.2KG
JD04-200W	670*280*100mm	3.9KG	670*280*100mm	1pcs	3.9KG
JD05-300W	800*280*100mm	4.3KG	800*280*100mm	1pcs	4.3KG

